

# STREET-WIDE VINYL BANNER

# 901.12

BANNERS & FLAGS

REVIEWED: 15.08.2025

THESE BANNERS ARE USED IN THE FOLLOWING LOCATIONS:

S1 - 1 BANNER ON JAMES ST

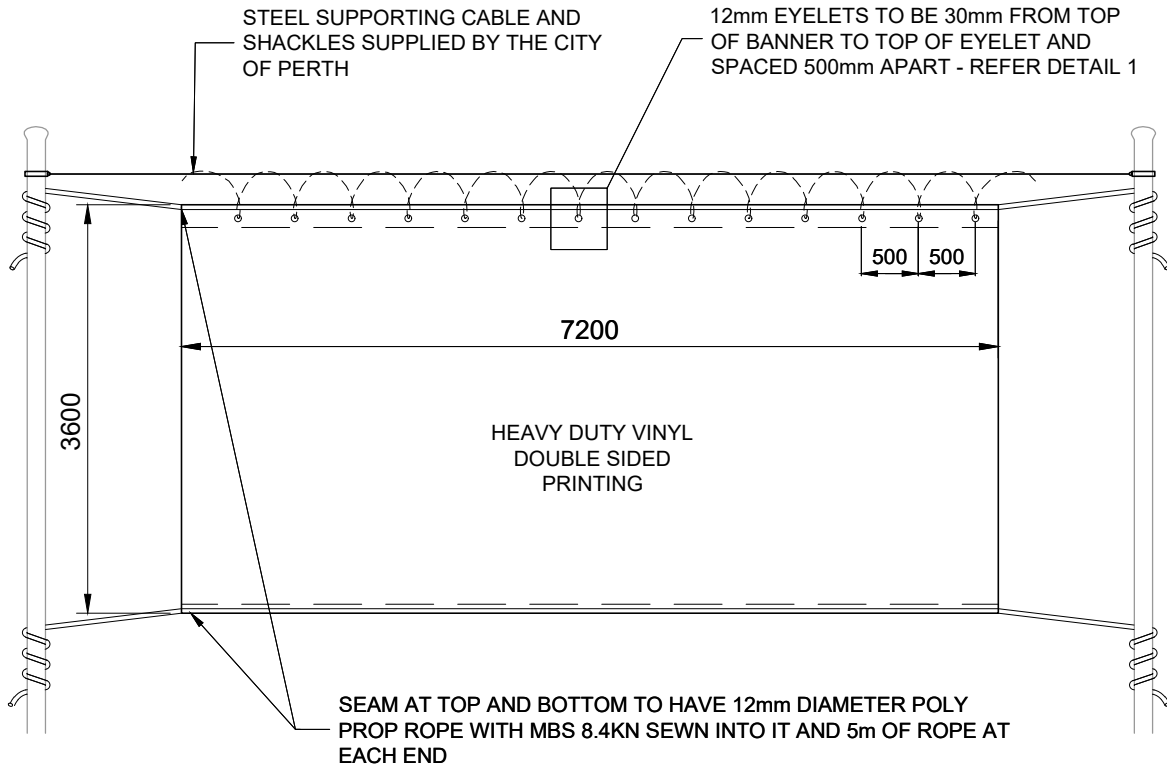

FRONT VIEW

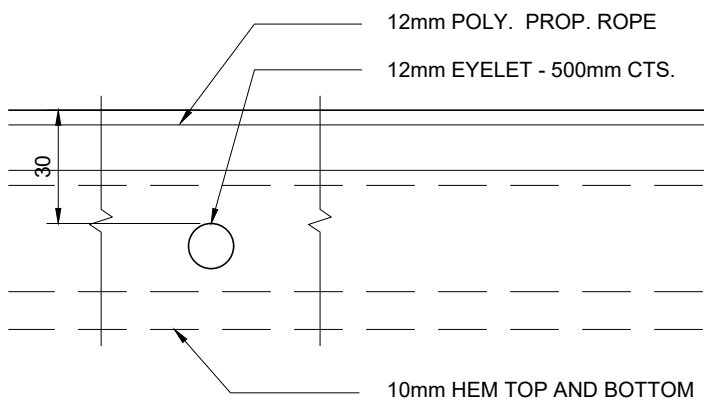

DETAIL 1

Notes:

1. Distance between poles at S2=13.25m
2. For General Notes refer *Design and Construction Note 900.02*.