

CITY OF PERTH

DESIGN & CONSTRUCTION NOTES

BOOK 600

ELECTRICAL AND LIGHTING

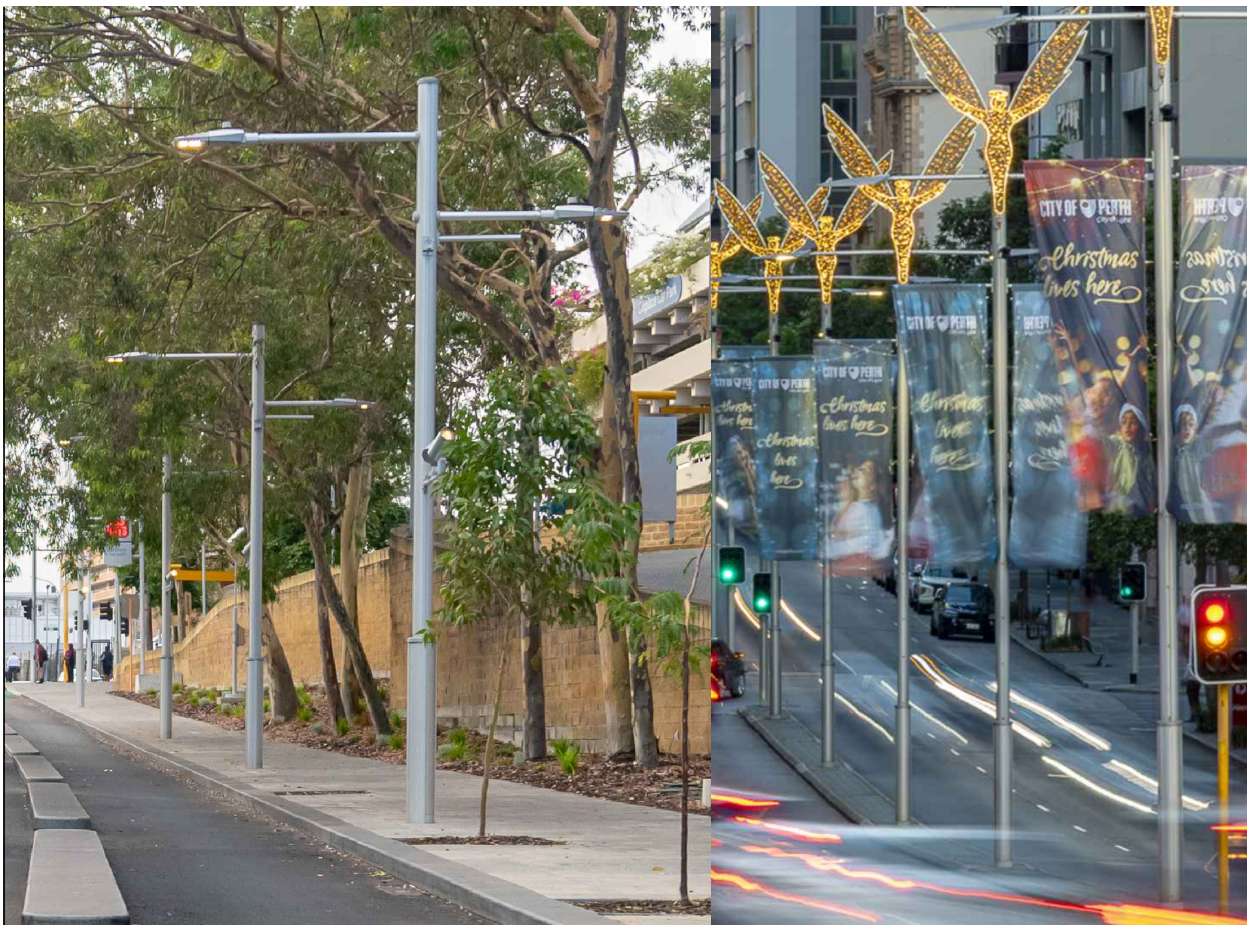

| REV | DATE | AMENDMENT |
|-----|------------|---|
| 2.0 | 19/07/2024 | REVIEWED, UPDATED AND RE-ISSUED FOR USE |
| | | |
| | | |

DISCLAIMER:

THIS DOCUMENT HAS BEEN PREPARED BY THE CITY OF PERTH AND IS SUBJECT TO CHANGE. IT IS THE RESPONSIBILITY OF THE USER TO ENSURE THAT DESIGN AND CONSTRUCTION NOTE HAS NO FURTHER REVISIONS BY CHECKING <https://perth.wa.gov.au/en/building-and-planning/building-and-works/building-and-construction-notes>

INDEX

| | |
|--------|------------|
| 600.00 | COVER PAGE |
| 600.01 | INDEX |

LIGHTING DESIGN SPECIFICATIONS / DESIGN CRITERIA

| | |
|--------|--|
| 601.00 | LIGHTING DESIGN SPECIFICATIONS / DESIGN CRITERIA |
| 601.01 | LIGHTING DESIGN SPECIFICATIONS / DESIGN CRITERIA |
| 601.02 | LIGHTING DESIGN SPECIFICATIONS / DESIGN CRITERIA |
| 601.03 | LIGHTING DESIGN SPECIFICATIONS / DESIGN CRITERIA |
| 601.04 | LIGHTING DESIGN SPECIFICATIONS / DESIGN CRITERIA |
| 601.05 | LIGHTING DESIGN SPECIFICATIONS / DESIGN CRITERIA |
| 601.06 | LIGHTING DESIGN SPECIFICATIONS / DESIGN CRITERIA |

STANDARD LIGHTING POLES

| | |
|--------|---|
| 602.00 | ALUMINIUM MULTIFUNCTION POLE - 12.0M POLE |
| 602.01 | ALUMINIUM MULTIFUNCTION POLE - 6.5M POLE |
| 602.02 | ALUMINIUM MULTIFUNCTION POLE - 4.8M TRAFFIC SIGNAL POLE |
| 602.03 | ALUMINIUM MULTIFUNCTION POLE - 4.0M CCTV POLE |
| 602.04 | STANDARD MULTIFUNCTION POLE FOOTINGS |

TYPICAL DETAILS

| | |
|--------|---------------------|
| 603.00 | SWITCHBOARD DETAILS |
| 603.01 | SWITCHBOARD DETAILS |
| 603.02 | TYPICAL DETAILS |
| 603.03 | TYPICAL DETAILS |

1.0 Equipment Installation

1.1 Location

All equipment shall be installed at locations shown on the Project drawings and in accordance with the manufactures requirements. The location of equipment without dimensions is indicative only. Exact location is to be confirmed with City of Perth Project Officer / Manager. As a general rule the following shall apply regarding the installation of equipment.

All electrical equipment shall be located to provide easy access by personnel for inspection, site maintenance and removal and replacement of components;

All equipment shall be installed strictly in accordance with the manufacturer's instructions and specifications;

Unless equipment is IP rated to the superintendent's satisfaction, all electrical equipment shall be located outside wet areas or areas that are prone to spillage. If required, deflectors and or guards shall be provided to protect equipment;

Adequate clearance for equipment door opening shall be provided in accordance with AS/NZ 3000. As a minimum a 600mm door clearance shall be provided.

1.2 Erection

All equipment shall be installed in accordance with AS/NZS3000 , Project drawings and manufacture's installation instructions. Where installation instructions are not provided and deemed necessary by the Superintendent, the Contractor shall provide details of the proposed installation to the City of Perth Project Officer / Manager for approval.

1.3 Degree of Protection

All electrical equipment enclosures shall provide the following minimum protection according to their location i.e. outdoor, indoors or within wet areas. The degree of protection shall be in accordance with AS 60529:

- Outdoor installations shall be IP65;
- Indoors installations shall be IP4X minimum; and
- Equipment installed within wet area indoors shall have minimum IP ratings as defined in AS/NZ 3000.

Electrical equipment located within a hazardous area classified zone shall comply with AS/NZS 2381.1

1.4 Switchboards

Switchboards supplied as part of the electrical installation shall comply with the requirements specified on the Project Documentation and AS/NZS 3000. as applicable.

Switchboards shall be complete with all necessary components, in compliance with AS 3439.

All switchboards shall have a minimum of 25% spare spaces for additional circuit protection and control devices. Spare spaces shall include busbars, mountings and individually blanked openings. Spare poles on MCCB chassis shall have insert type pole fillers.

2.0 Cables General Installation

The Project electrical drawings detail the general route for the cables. Any changes to the routes shall be approved by the City of Perth Project Officer / Manager prior to any works commencing.

Underground low voltage cables shall be installed in conduit. Cables not installed underground must be reticulated along pathways with suitable mechanical protection. In general this shall be achieved using cable trunking, cable ladder or conduit (HD PVC or galvanised steel conduit as approved by City of Perth Project Officer / Manager). Where cables are required to terminate at field equipment, they shall be mechanical protection for the final length of cable.

All cables shall be installed in accordance with the cable As/NZS 3000.. Consideration shall be given to the minimum cable bending radii and maximum cable pulling tensions.

All non UV resistant cables shall be installed in either cable ladder with a top cover, continuous steel conduit or similar to prevent UV damage.

All final connections to equipment such shall be completed using flexible cables where required.

The correct phasing and connection of all cables shall be checked and verified.

All cable lengths shown in the cable schedule or listed on the drawings are estimated route lengths only and in all cases are approximate. Exact final lengths shall be verified by the Contractor prior to cutting cables.

All underground cables, whether in conduit or direct buried, shall have an approved cable warning tape buried approximately 300mm below finished ground level directly above the cable run.

2.1 Segregation of Cables

Suitable segregation shall be maintained between electrical services grouped together as follows:

- High voltage cables;
- Low voltage and lighting; and
- Communication cables (including Control and instrumentation cables)

Segregation between low voltage and high voltage cables shall be 300mm clear.

Segregation between Control, instrumentation & communication cables and low voltage cable shall be 150mm clear.

Generally each group shall be allocated to a separate enclosure, unless otherwise indicated on the Project electrical drawings.

2.2 Cable Joints

Cable joints shall not be allowed unless approved by the City of Perth Project Officer / Manager.

2.3 Cable Trenching

All electrical and communication conduits shall be installed in accordance with AS/NZS 3000, AS/NZS 3007, relevant statutory authorities and project standard drawings.

Cables trenches shall be of adequate depth to provide the following minimum cover over underground conduit for the entire length of the trench.

| | |
|--------------------------|--------|
| Bare earth cables: | 600 mm |
| All low voltage cables: | 600 mm |
| All high voltage cables: | 850 mm |

A minimum of 150mm of sand bedding shall be provided in the trench below the bottom conduit.

Electrical conduits in trenches shall be taken over or under obstructions such as proposed/existing water pipes or sewers pipes. The trench shall be excavated to ensure minimum statutory segregation distances between services.

All trenches shall be excavated to accommodate the conduits, spacing/segregation and conduit (cable) installation configuration (trefoil etc.) required to complete the installation.

A continuous strip of 150 mm wide orange PVC electrical marker tape shall be installed not more than 300 mm above the cables over the full width of the trench and for the full length of the underground route.

Concrete cable markers shall be visible and located on the surface at each change of detection to identify the cable route.

2.4 Conduits

Conduit shall be galvanised steel or heavy duty PVC for underground or cast-in concrete installations (unless specified otherwise). Above ground conduits shall be galvanised conduit to AS 2053 or PVC conduit with UV resistant depending on the environment in which the conduits will be installed.

All cables leaving trenches shall pass through a PVC conduit sleeve which finish 150mm above finished ground level. The space around cables exiting conduit sleeves shall be filled with non deteriorating, non-setting, weatherproof sealant

All conduit, where installed in a hazardous area shall be certified for the particular area classification.

For underground conduit runs draw pits shall be installed at intervals not exceeding 50m. For all changes in direction draw pits or large sweeping bends shall be sized to suit the minimum bending radii of the cables to be installed. For all conduits entering/exiting underground pits, the outside of the conduits shall be sealed with a suitable compound to maintain the water tight integrity of the pit.

All pits shall be rated to suit the installation location with particular attention to the traffic rating of the pits and associate lids for the application.

3.0 Cable Connection and Jointing

3.1 Low Voltage Power Cables

Low voltage cables shall be terminated through a glanded conduit entry and the tails shall be fitted with crimped cable lugs of the correct type and size for the cable.

All unused cable entries shall be closed with screwed plugs.

3.2 Cable Glands

All cables entering into equipment shall do so through approved weatherproof compression type cable glands from a single manufacturer. The glands shall be either screwed into the equipment or fitted with a sealing washer and lock nut.

Cable glands for armoured cable shall be compatible with the type of cable and shall be fitted with brass earthing tags.

The gland size shall be chosen for each cable size to the manufacturer's recommendations, but the actual finished size of the cable shall be the ruling factor.

PVC shrouds shall be provided for outdoor cable glands.

3.3 Cable Connectors

All cable lugs, bolts, nuts, washers, pins or connectors shall be provided as required to terminate cables.

4.0 Labelling and Signage

4.1 Equipment

Equipment labels shall comply with Project Documentation

In general the following shall apply :

A typical label for switchboards shall be provided for approval by the Superintendent before all labels are manufactured.

All circuit breakers shall be labelled with the device number corresponding to the relevant schematic / single line diagram and Legend;

Circuit schedules in distribution switchboards shall be typed on cards which are protected by transparent plastic cover, housed inside the door; and

Fixing of labels shall not void the IP rating or certification of the equipment.

5.0 External Lighting

External lighting shall be installed in accordance with manufacturer's recommendations and complete with the following:

- Secure fixing to site (eg concrete plinth for in-ground up-lighters, bollards, etc).
- Free from moisture.
- Vandal resistant screws.
- Vandal resistant materials.
- UV Stabilised.
- Where painted, final colour shall be to Superintendents approval and paint shall be anti-graffiti full height.
- Where located within 5 km of the river, ensure all fixings are marine grade aluminium, 316 grade stainless steel, or hot dipped galvanised steel. Ensure dissimilar metals are adequately separated to prevent corrosion.
- All lighting circuits shall be protected by RCDs in accordance with AS/NZS 3000.
- All fittings shall be clean and all lamps shall be new at Practical Completion.
- All components forming the luminaire shall be compatible to achieve the performance nominated in manufacturer's published data.
- Luminaire manufacturer certified IP Ratings to AS60529 shall not be compromised or reduced due to incorrect or poor installation.
- The IP rating specified for luminaires shall be maintained through installation of fixings, supports and wiring.

6.0 Poles

6.1 Multi function Poles (MFP)

MFP's shall be supplied from City of Perth approved suppliers complete with all associated brackets and requirements.

The Contractor shall liaise with MFP supplier to ensure all components including baseplate, outreach arm etc are provided with the poles. Inspect the poles and accessories upon delivery and ensure that all components for the complete installation are provided.

The Contractor shall be responsible for coordination and assembly of luminaire mountings and foundations / rag bolts interface, mounting brackets for equipment within the pole bases and access openings.

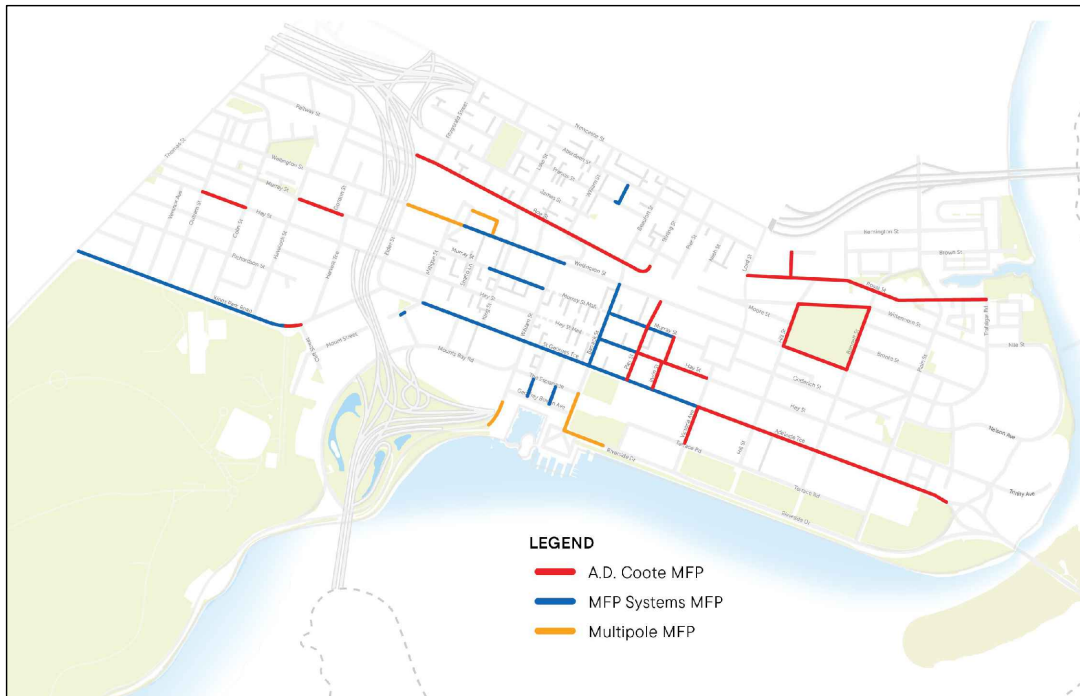

Existing MFP Location Map

6.2 Fabrication

Poles, bases, foundations and holding down bolts shall be designed in accordance with the appropriate Australian Standard to suit the soil and wind loading conditions of the site and shall be certified by a practising structural engineer.

An opening for a minimum of four 50mm large sweep conduit bends (2 x electrical and 2 x communication) shall be provided through the base plate.

Poles shall be complete with all necessary brackets, spigots and ferrules to suit light fittings, etc. Poles shall be base-plate mounted.

6.3 Access to Pole Bases

Provide weatherproof (IP56) covered hand holes near the base of all lighting poles to gain access to switchboard/enclosure containing terminations, circuit protection device and control gear. All poles shall be fitted with MCB/RCD. Provide anti vandal fixings to all access doors. Size and number of access doors shall be provided to suit the switchboard/enclosure and remote control gear. Coordinate requirements with pole manufacturer during pole shop drawing stage.

6.4 Equipment in Pole Base

Insulated and IP56 switchboard/enclosure terminal boxes shall be provided for the incoming conductors and the luminaire connections. The terminals shall be of adequate size for wire sizes and equipment shown and should generally be of the type which does not provide connection directly between the terminal screw and the conductor. Alternatively where direct screw type terminals are used cable ends must be soldered.

Electrical services installed close to non-electrical services shall be arranged so that any routine operation carried out on the other services will not cause damage to the electrical services.

Separation of communication cables from electrical cables shall comply with AS/NZS 3000.

ALUMINIUM MULTIFUNCTION POLE - 12.0M POLE

602.00

ELECTRICAL - LIGHTING

REVIEWED: 19.07.2024

| CITY OF PERTH SUPPLIER | |
|------------------------|----------------------------|
| NAME/ COMPANY | A.D. COOTE & CO. |
| CONTACT DETAILS | EMAIL: info@adcoote.com.au |
| | TEL: +61 8 9361 7666 |

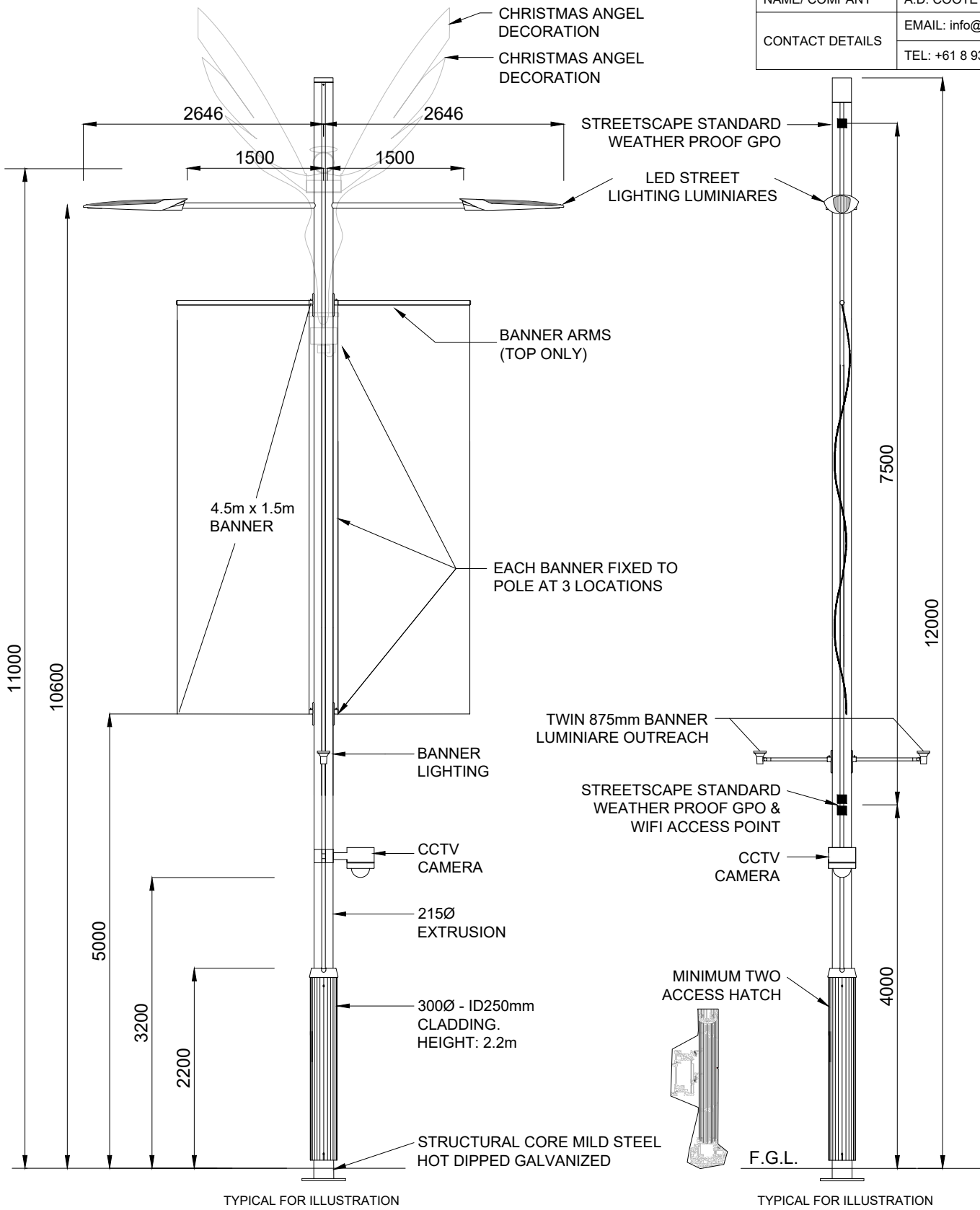

- NOTE:
1. All accessories (lighting, outreach arms, CCTV cameras, etc.) to be fixed use standard fixing plates by the pole supplier.
 2. The base plate, structural core & bolting system shall be hot dipped galvanized steel. Bolting system & foundation shall be designed & signed off by an experienced & NER registered structural engineer.
 3. Access hatch must face away from hazards / traffic for access / maintenance.

ALUMINIUM MULTIFUNCTION POLE - 6.5M POLE

602.01

ELECTRICAL - LIGHTING

REVIEWED: 19.07.2024

| CITY OF PERTH SUPPLIER | |
|------------------------|----------------------------|
| NAME/ COMPANY | A.D. COOTE & CO. |
| CONTACT DETAILS | EMAIL: info@adcoote.com.au |
| | TEL: +61 8 9361 7666 |

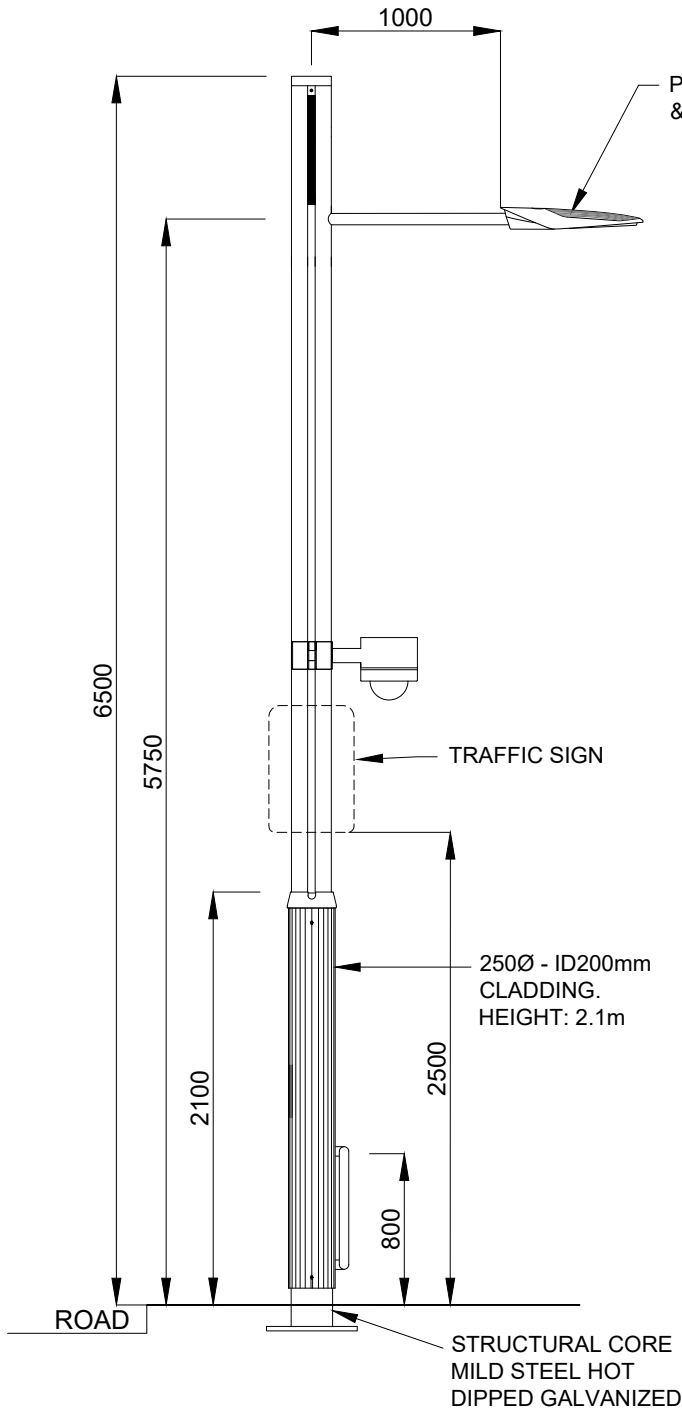

TYPICAL FOR ILLUSTRATION

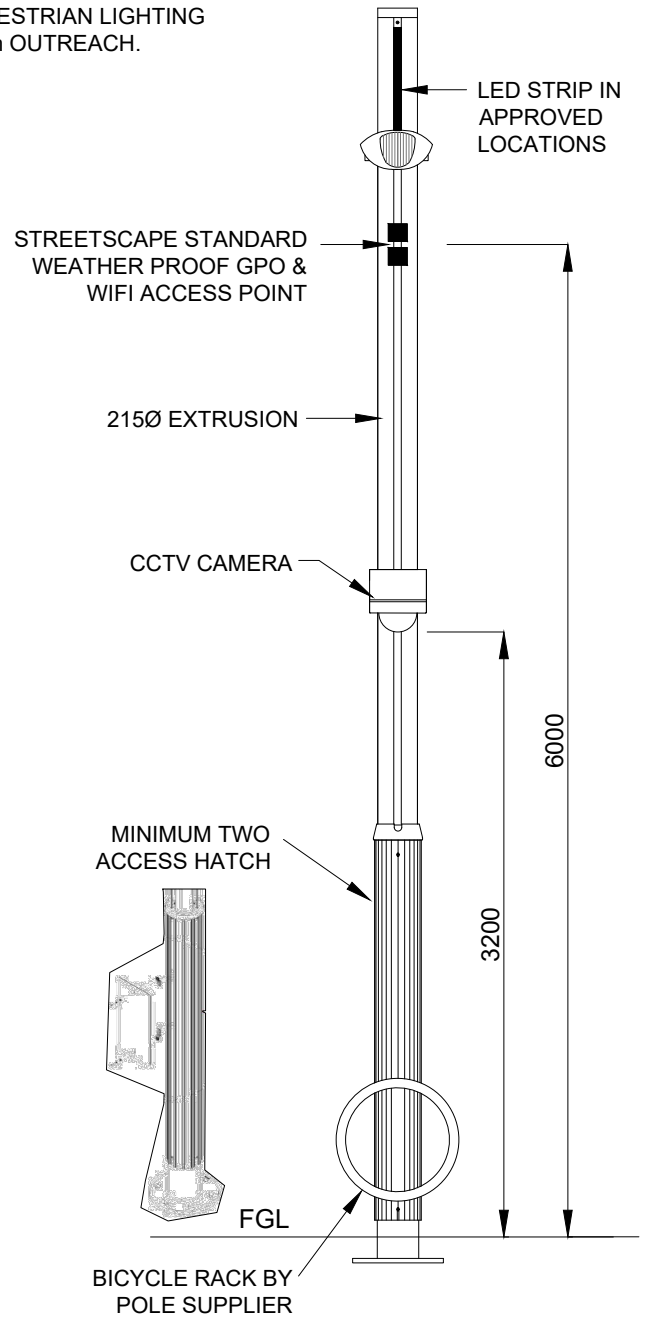

TYPICAL FOR ILLUSTRATION

NOTE:

1. All accessories (lighting, outreach arms, CCTV cameras, etc.) to be fixed use standard fixing plates by the pole supplier.
2. The base plate, structural core & bolting system shall be hot dipped galvanized steel. Bolting system & foundation shall be designed & signed off by an experienced & NER registered structural engineer.
3. Access hatch must face away from hazards / traffic for access / maintenance.

| CITY OF PERTH SUPPLIER | |
|------------------------|----------------------------|
| NAME/ COMPANY | A.D. COOTE & CO. |
| CONTACT DETAILS | EMAIL: info@adcoote.com.au |
| | TEL: +61 8 9361 7666 |

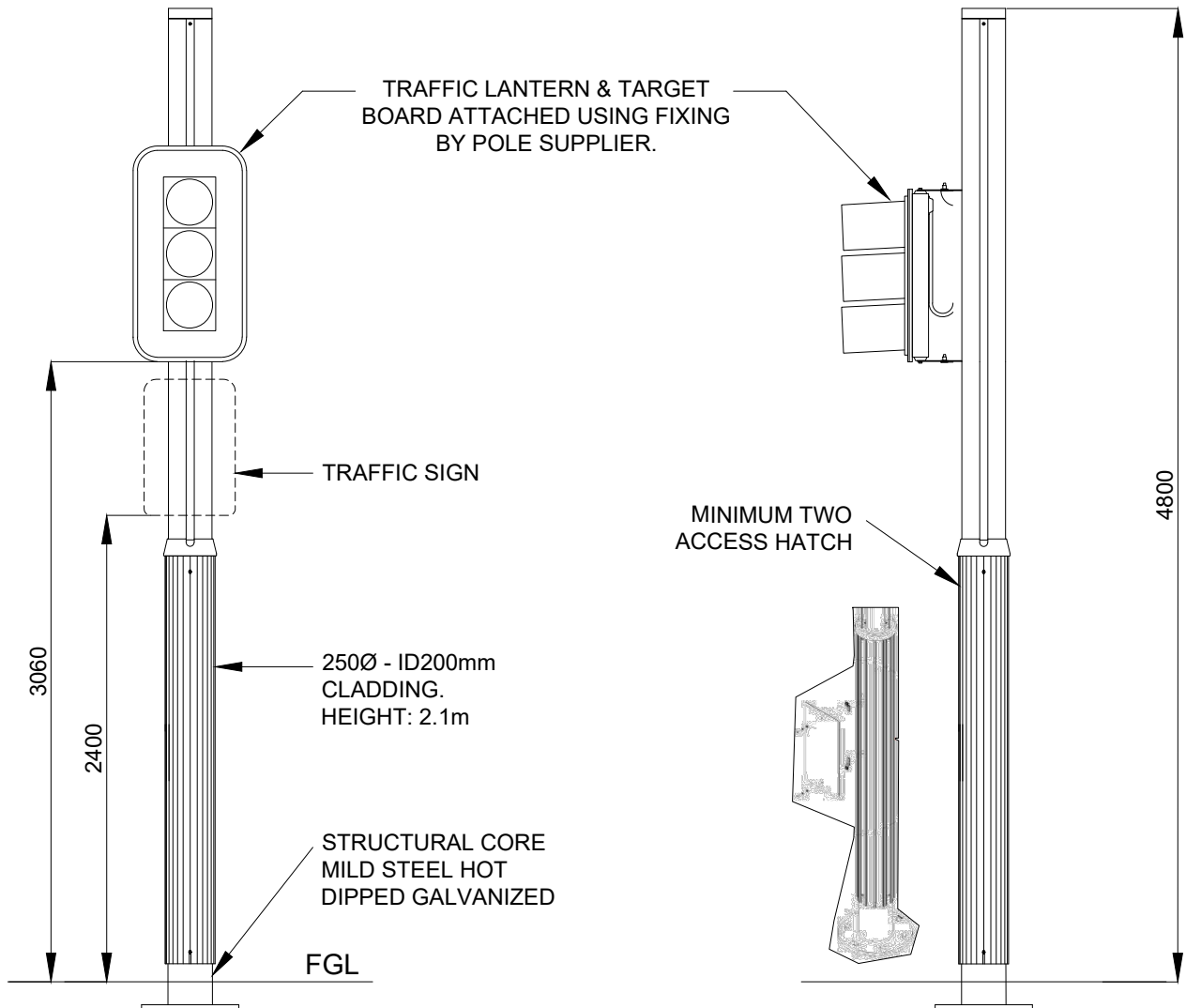

TYPICAL FOR ILLUSTRATION

TYPICAL FOR ILLUSTRATION

Fixing MRWA assets (traffic lanterns) to COP owned poles is pending MRWA approval.

NOTE:

1. All accessories (lighting, outreach arms, CCTV cameras, etc.) to be fixed use standard fixing plates by the pole supplier.
2. All Traffic Signals installed on poles other than MRWA standard must be approved by MRWA.
3. Standard Traffic Signal fixing to be adjusted to fit multi-function pole fixing style.
4. Traffic Signals may be installed on larger sized poles, at heights shown, if necessary, pending MRWA approval.
5. The base plate, structural core & bolting system shall be hot dipped galvanized steel. Bolting system & foundation shall be designed & signed off by an experienced & NER registered structural engineer.
6. Access hatch must face away from hazards / traffic for access / maintenance.

ALUMINIUM MULTIFUNCTION POLE - 4.0M CCTV POLE

602.03

ELECTRICAL - LIGHTING

REVIEWED: 19.07.2024

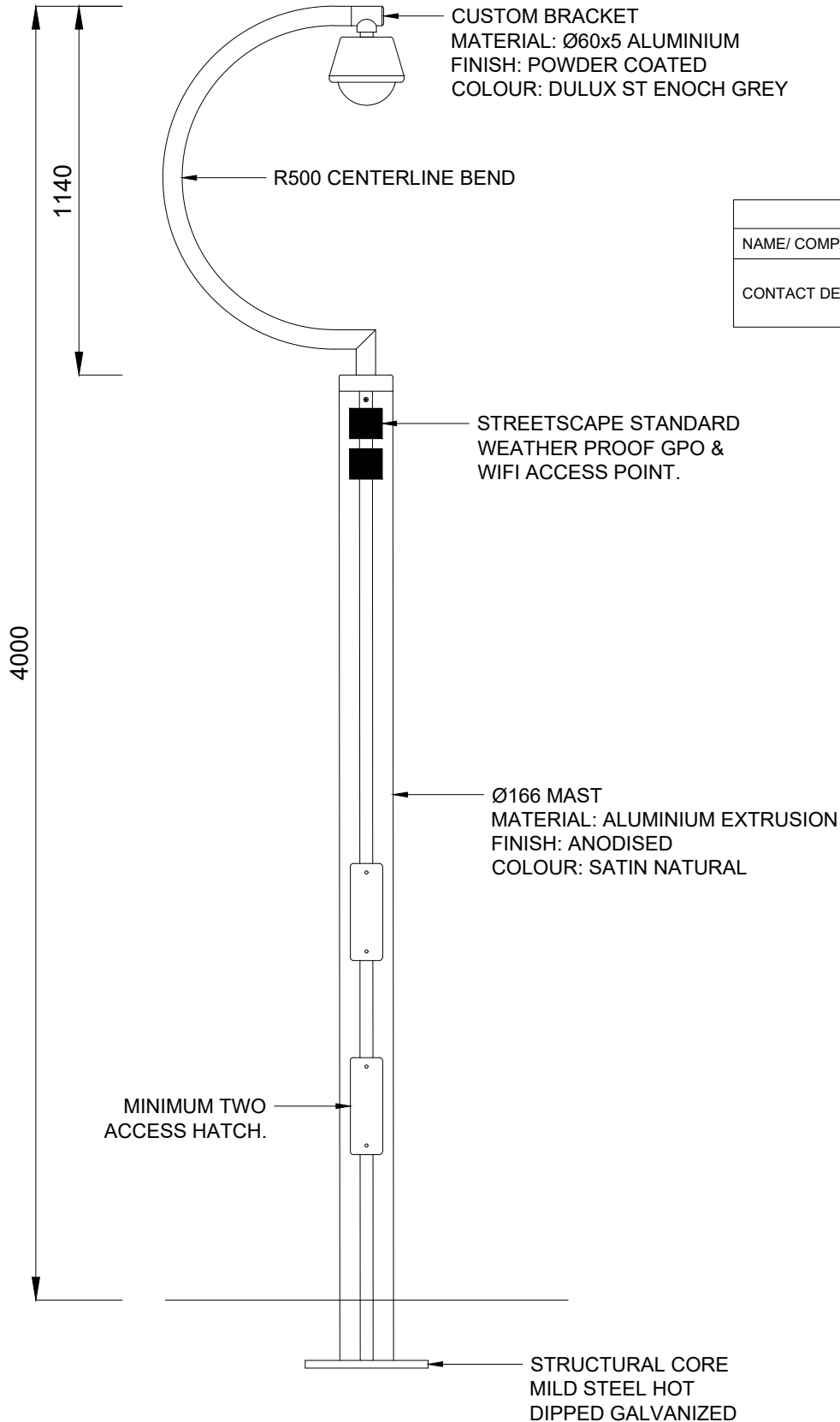

| CITY OF PERTH SUPPLIER | |
|------------------------|----------------------------|
| NAME/ COMPANY | A.D. COOTE & CO. |
| CONTACT DETAILS | EMAIL: info@adcoote.com.au |
| | TEL: +61 8 9361 7666 |

TYPICAL FOR ILLUSTRATION

NOTE:

1. The base plate, structural core & bolting system shall be hot dipped galvanized steel. Bolting system & foundation shall be designed & signed off by an experienced & NER registered structural engineer.
2. Access hatch must face away from hazards / traffic for access / maintenance.

STANDARD MULTIFUNCTION POLE FOOTINGS

602.04

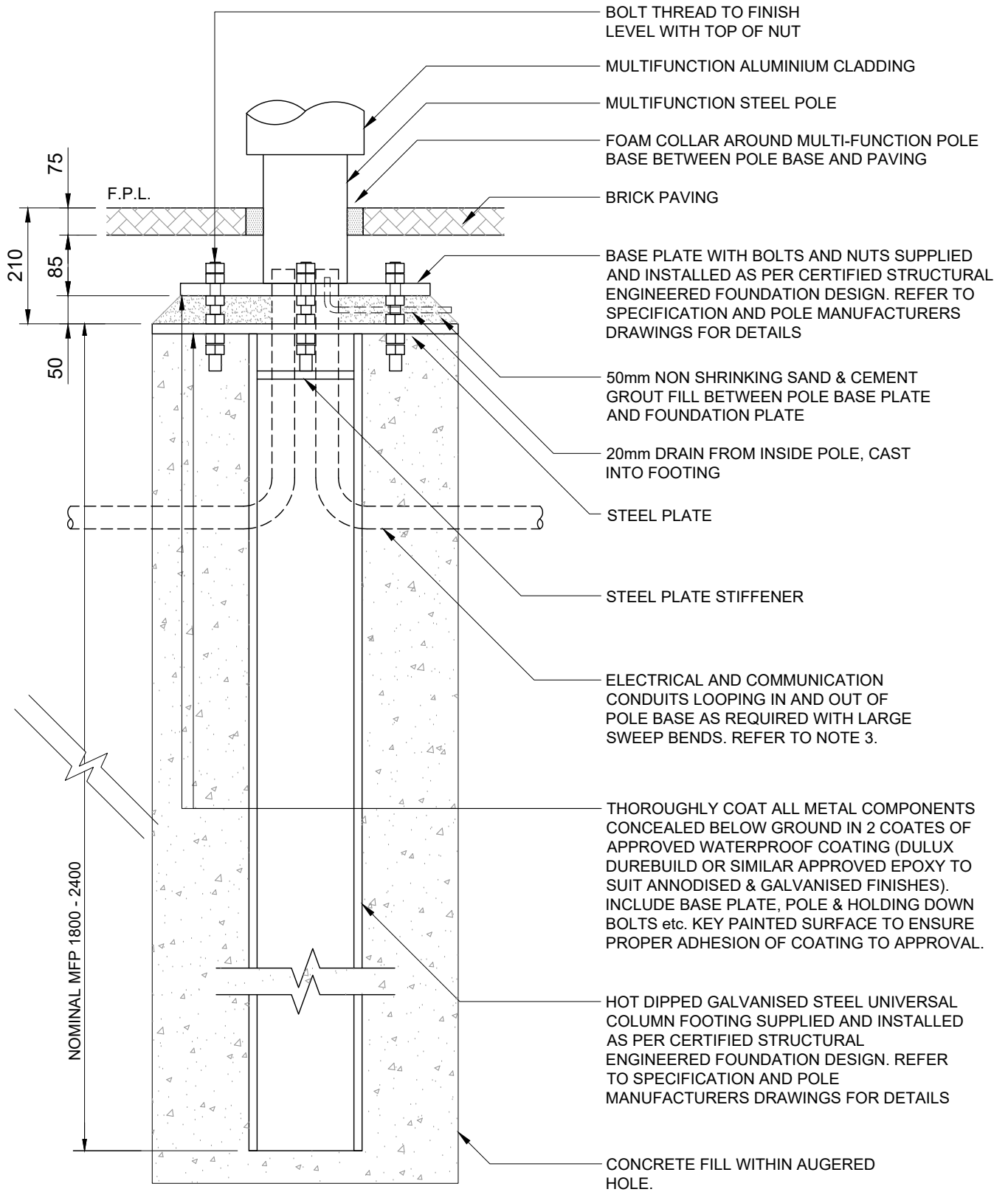

NOTE: Pole foundations to be structurally designed and certified by practicing structural engineer in accordance with site conditions, Australian standard and manufacturers recommendations. Submit shop drawings and structural engineered certification for review prior to manufacture and installation.

DESIGN & CONSTRUCTION NOTE
SWITCHBOARD DETAILS

ELECTRICAL - LIGHTING

DRAWING NO

603.00

REVIEWED: 19.07.2024

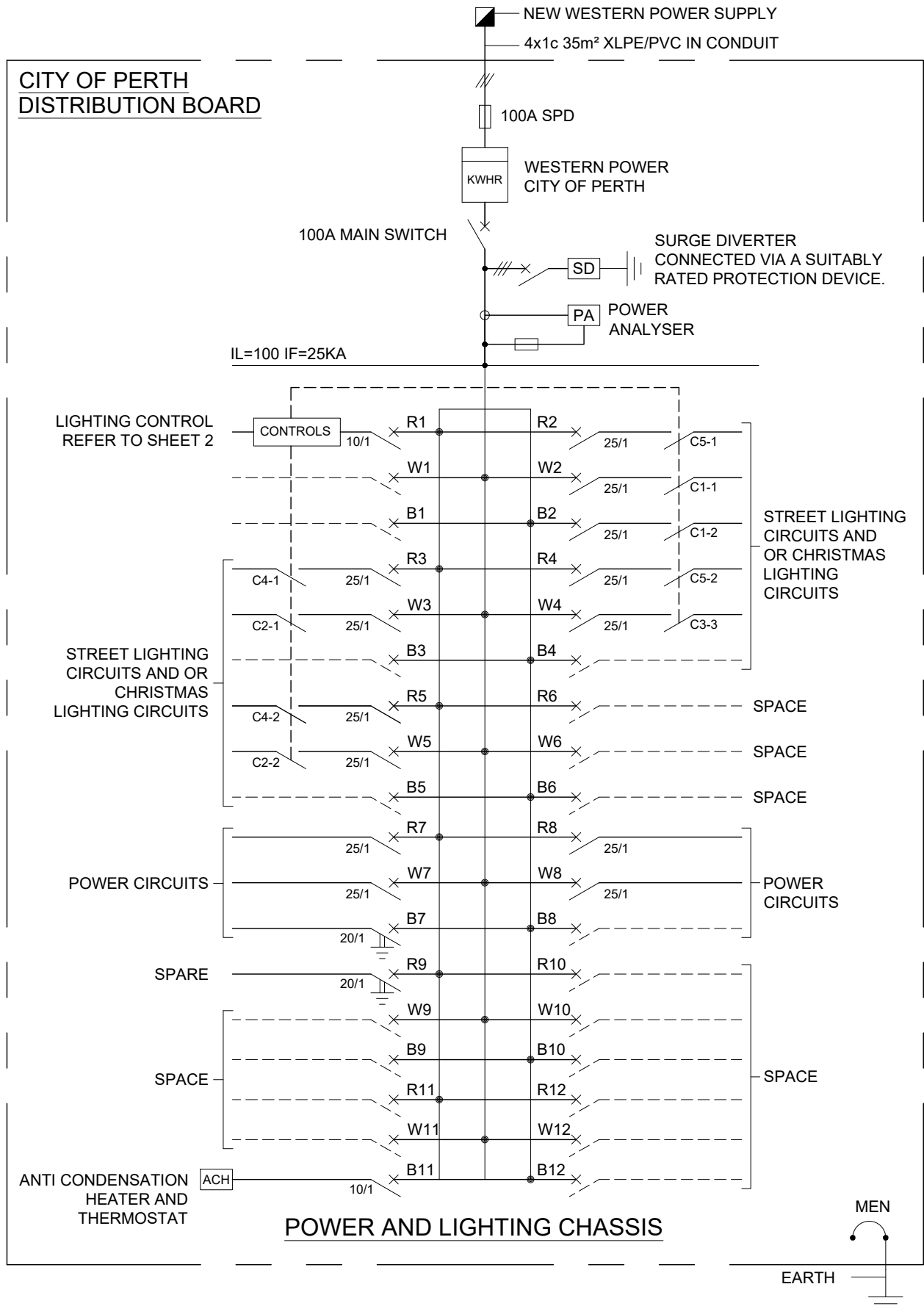

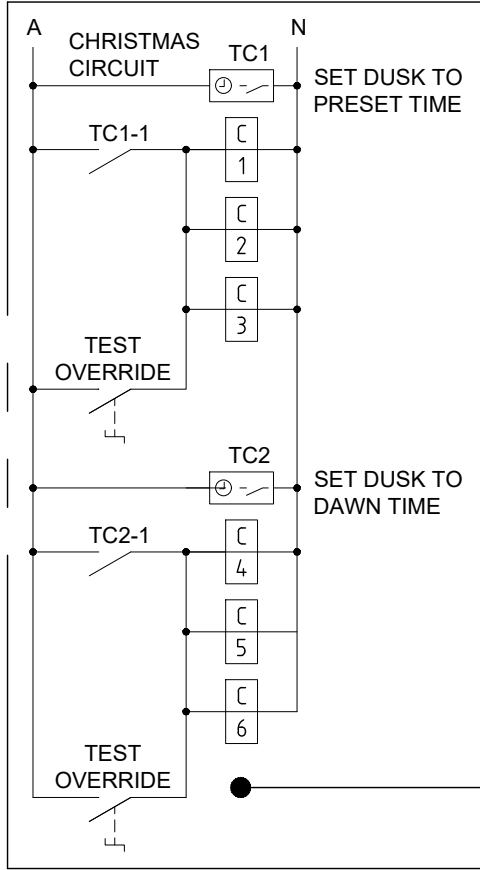

SWITCHBOARD CONSTRUCTION NOTES

CONSTRUCTION DETAILS:

- IP56, 25KA, FORM 2bIH
- FREE STANDING CUBICAL
- 2.5mm THICK MARINE GRADE ALUMINIUM
- SLOPPED SUN SHADE
- WEATHER AND INSECT PROOF VENTILATION LOUVERS (IP54)
- LIFT HINGED DOORS WITH 3 POINT LOCKING
- VANDAL RESISTANT DOOR, ADDITIONAL 30x15mm 4mm ALUMINIUM CHANNEL INSIDE DOOR. HINGE SCREWS TO BE FIXED WITH STAINLESS STEEL SHIM PLATES
- DOOR STAYS
- LEGEND HOLDER
- SELECTLOK SWING HANDLES WITH RECESSED DOOR LOCKS
- LOCKED DOORS TO CITY OF PERTH COP600 AND WESTERN POWER REQUIREMENTS
- ALUMINIUM PLINTH
- BOTTOM CABLE ENTRY
- EXTERNAL FINISH ROLLER PAINTED, DULUX FERRADOR
- 810 COLOUR ST-ENOCH GREY
- INTERNAL FINISH, NATURAL

LIGHTING CONTROL

NOT TO SCALE

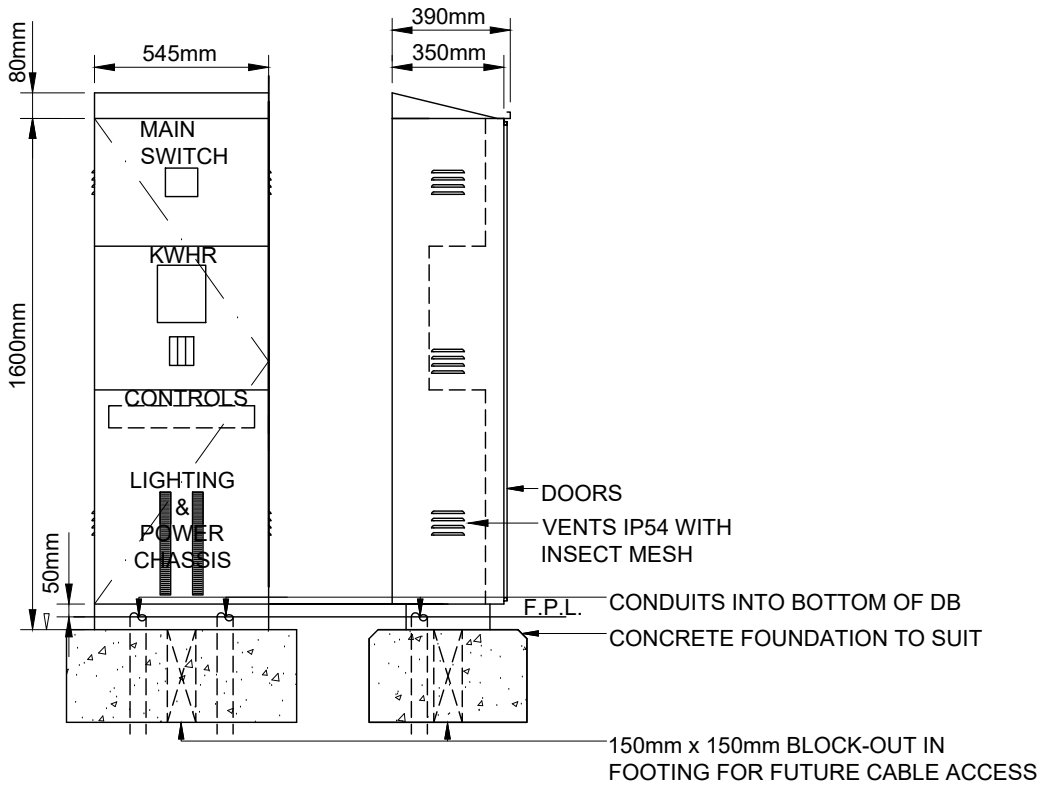

DISTRIBUTION BOARD DETAIL

NOT TO SCALE

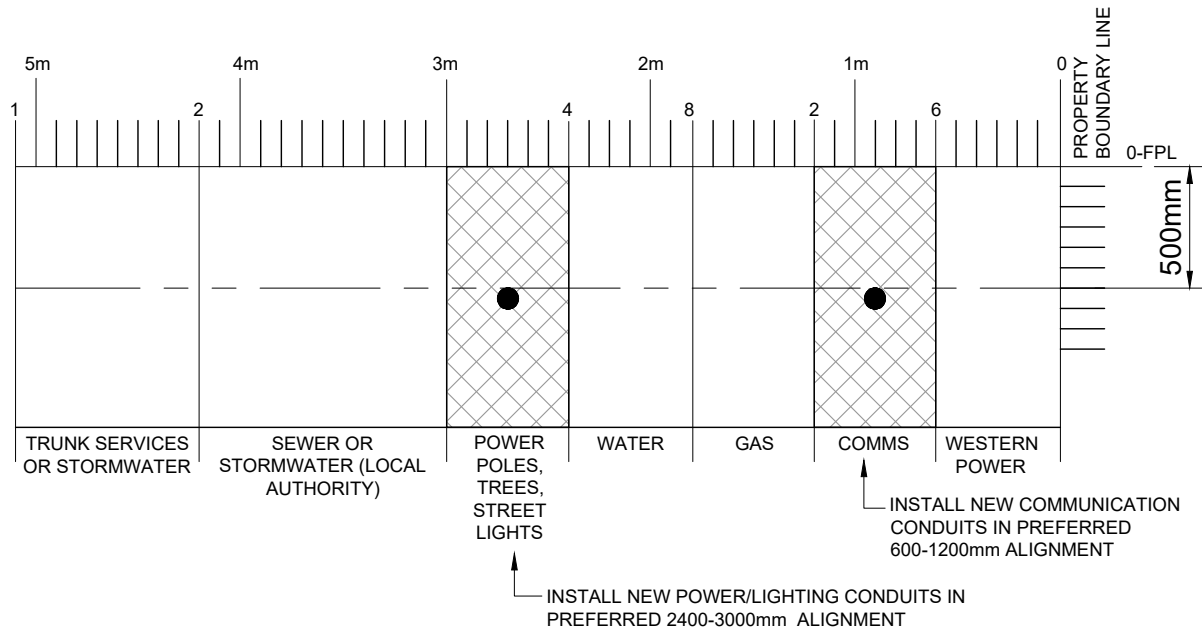

TYPICAL SERVICE ALIGNMENT
NOT TO SCALE

NOTE: VERIFY AND CONFIRM FINAL SERVICE ALIGNMENT ONSITE WITH THE CITY OF PERTH PRIOR TO COMMENCEMENT OF WORK

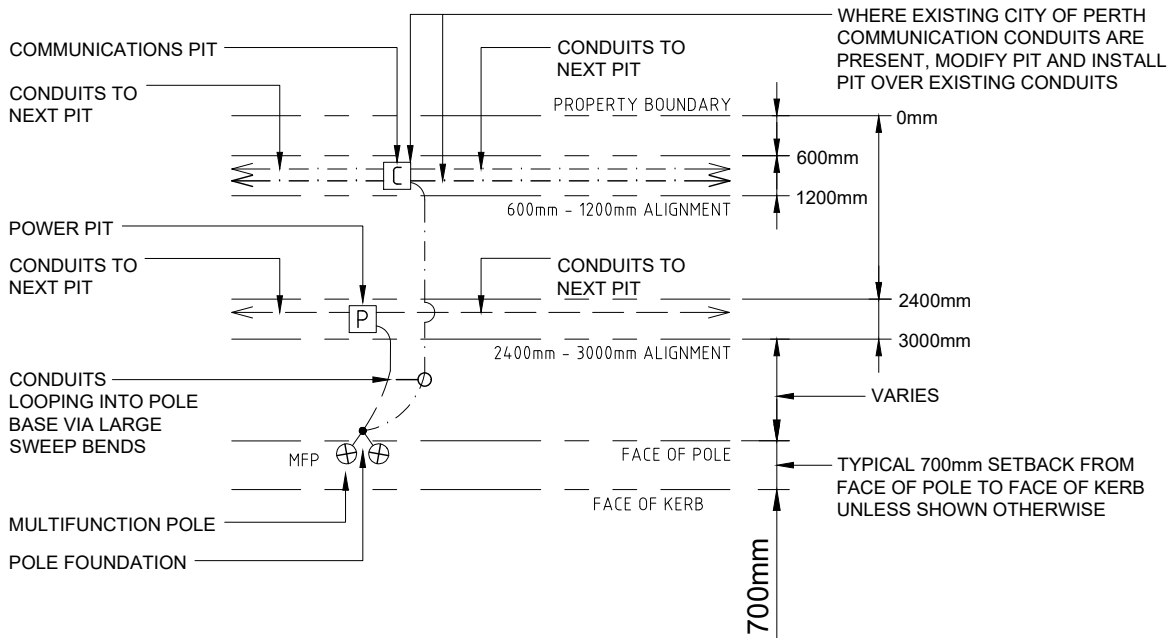

TYPICAL PIT AND CONDUIT DETAIL
NOT TO SCALE

NOTE: CONFIRM FINAL SERVICE ALIGNMENT ONSITE WITH THE CITY OF PERTH PRIOR TO COMMENCEMENT OF WORK

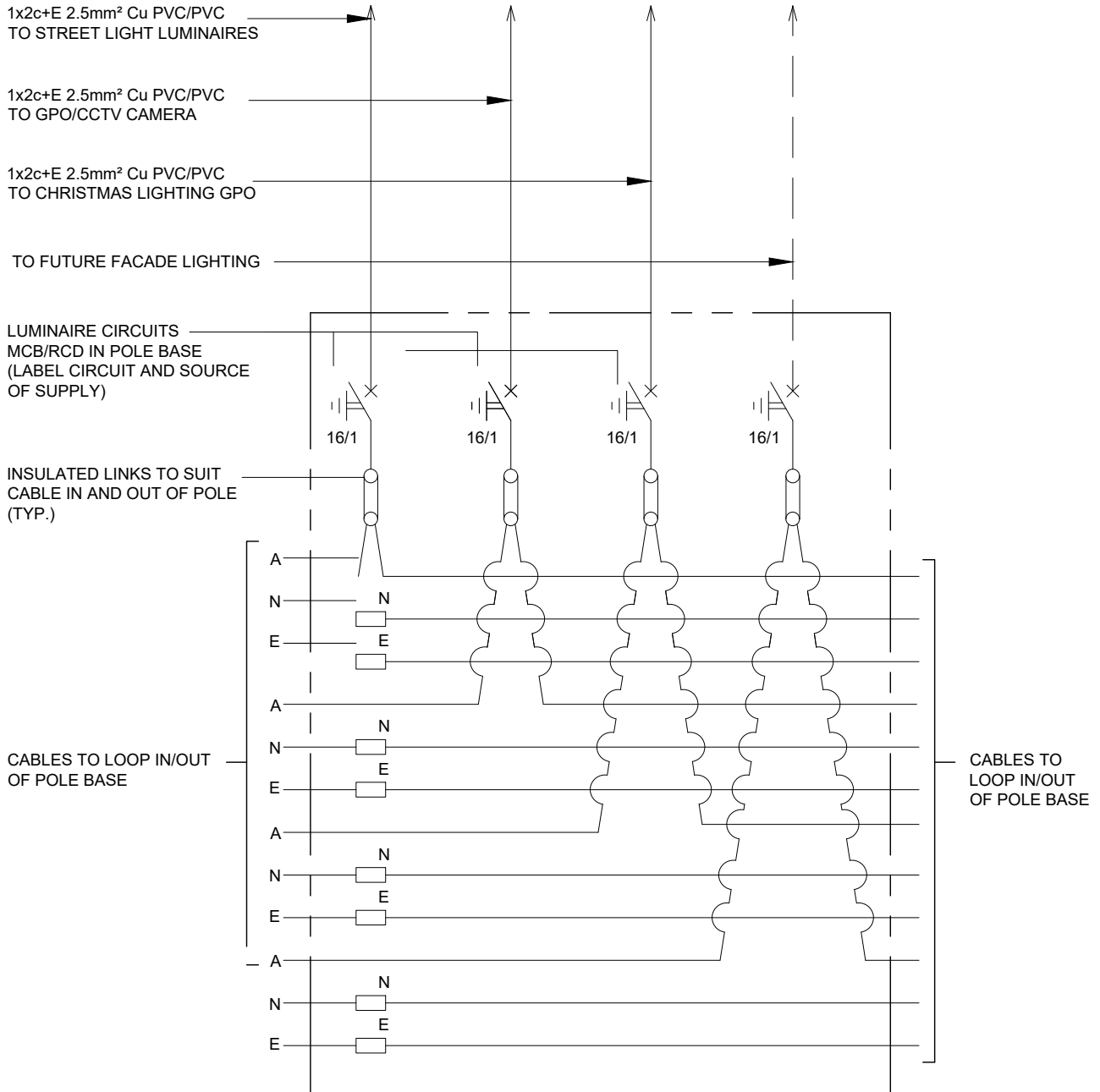

PROVIDE FIXED WARNING LABEL WITHIN POLE BASE

WARNING MULTIPLE SUPPLIES
ISOLATE ALL SUPPLIES AT ORIGIN OF SUPPLY/ DISTRIBUTION BOARD PRIOR TO COMMENCING ANY WORKS

TYPICAL WIRING SCHEMATIC
NOT TO SCALE